



Ventilation system inVENTer PAX – Standard set

Installation and operating instructions



Trademarks, copyrights and property rights

inVENTer® is a registered trademark of inVENTer GmbH.

The copyright of this document remains with the manufacturer.
Rights to all contents and images: © inVENTer GmbH 2016-17.

All trademarks used in this document are the property of their respective manufacturers and are hereby acknowledged.

Disclaimer

This documentation is an translation of the original German installation and operating instructions. After completion of the installation it must be given to user (tenant, owner, property management, etc.).The content of this documentation has been checked for compliance with the described hardware and software. Nevertheless deviations may still occur, therefore no guarantee of compliance can be provided.This documentation describes the functionality of the standard scope. The documentation does not purport to cover all details on all types of the product and cannot cover every conceivable scenario for installation, assembly, operation, cleaning and maintenance.The illustrations in this document may differ slightly from the design of the product that you have purchased. The same functionality is ensured despite any design deviations.

This documentation is updated regularly. Necessary corrections and appropriate supplements are always included in subsequent editions. You can find the latest version at www.inventer.eu/downloads

Table of contents

1	User and safety instructions	5
1.1	User information.....	5
1.2	Safety instructions.....	6
2	System overview	8
2.1	Construction.....	9
2.2	Function	10
2.3	Control elements.....	12
3	Preparing for installation	13
3.1	Installation advices.....	13
3.2	Dimensions	14
3.3	Installation situation inVENTer PAX standard set	14
3.4	Dimension drawing	15
3.5	Installation conditions for connection over the roof.....	16
4	Assembly and installation	17
4.1	Check the scope of supply.....	17
4.2	Create wall opening/drill holes	18
4.3	Install the mounting plate	19
4.4	Insert the wall ducts	19
4.5	Mount the main module	21
4.6	Connect the main module	24
4.7	Mount the weather protection hood	26
5	Operation.....	28
5.1	Open grille cover.....	28
5.2	Operating the ventilation unit via user interface on the main module	28
5.3	Operating the ventilation unit with infrared remote control.....	31
6	Cleaning and maintenance	32
6.1	Switching on/off the ventilation unit via main ON/OFF switch.....	33
6.2	Setting the filter change interval.....	34
6.3	Replace the dust filters	36
7	Specifications	38
8	Scope of supply.....	40
9	Accessories	40
10	Troubleshooting and disposal	41
11	Guarantee and warranty	42
12	Service.....	42
	Company details.....	43

1 User and safety instructions

Thank you for purchasing this high quality product from inVENTer!

This section provides an overview of the basic safety precautions for safe and proper operation of your ventilation unit.

1.1 User information

Concept of safety instructions

The safety and warning instructions in these operating instructions have a uniform structure and are marked with a symbol on the left side of the instruction. A signal word above the text also indicates the hazard level. If several hazard levels exist, the highest level safety instruction is always used.



SIGNAL WORD

Type and origin of the hazard.

Possible consequences of the hazard!

► Measures to avoid the hazard.

A signal word indicates the severity of the potential hazard unless the preventative measures are taken.



DANGER indicates: Direct danger of serious injury or death.



WARNING indicates: Imminent danger of serious injury or death.



CAUTION indicates: Imminent or possible risk of minor/significant injury.



NOTICE indicates: Imminent or possible damage to the property due to an adverse event/state.

Other symbols used in this documentation

In addition to the safety instructions, the following symbols are used:



A **TIP** symbol indicates practical and useful tips for handling your ventilation unit.



A **tool** symbol before an installation sequence lists any additional tools and materials required for the described task.



A **red bar** over a graphic indicates: Graphic shows the interior wall.



A **blue bar** over a graphic indicates: Graphic shows the exterior wall.

► **Action required:** This requires you to perform a specific action.

⇒ **Check the results:** this requires you to check the results of the action you have performed.

→ **Coloured arrows in graphics:** Specifies location of the action when necessary.

1.2 Safety instructions



These installation and operating instructions are part of the ventilation unit and must be permanently available. When handing the equipment/system to a third party, the installation and operating instructions must be handed over also. Before performing any work on the system, read the installation and operating instructions carefully and observe all information regarding installation, commissioning and maintenance contained in this section. Also note the safety instructions that precede the described handling instructions.

Non-observance of safety warnings could result in injury and/or property damage.

Intended use

The ventilation device is designed to ventilate dwellings and similar residential spaces.

Observe the relevant standards, regulations and guidelines, especially the applicable building codes and fire and accident prevention regulations issued by the respective trade association. Use the equipment/system exclusively for the applications that are described in this documentation and only in conjunction with components that are recommended, authorised and described by inVENTer GmbH in this documentation. Changes or modifications to the equipment/system are not permitted.

- Trouble-free and safe operation of the equipment depends on proper transportation, proper storage and installation as well as careful operation and maintenance.
- Before starting work, you should have a ventilation concept from which the number of ventilation units and their position can be determined.
- The ventilation system may only be commissioned after completion of the construction project.
- The volume of supply air should match the volume of extract air. We recommend an external air supply for inVENTer PAX. This may be realised by appropriate overflow measures: an air gap of about 10 mm below the door, unscrew the hinges by 5 mm, use a ventilation grille or similar.
- **DANGER:** When laying the power supply cable, observe the requirements of protection class II.
- **DANGER:** Ensure that the power supply (voltage, frequency and phase) correspond to the specifications on the type plate.
- **DANGER:** The inVENTer PAX is designed for fixed installation with permanent cabling.
- **CAUTION:** Installation and electrical connection may only be performed by qualified and trained personnel.
- **CAUTION:** Operation and/or maintenance of the device must not be carried out by children and/or persons who are not fully capable of doing so due to their physical, sensory or mental capabilities, inexperience or lack of knowledge. Young children should be supervised to ensure that they do not play with the device.
- Before performing cleaning or maintenance tasks, disconnect the power supply and put on gloves.
- **NOTICE:** Install the wall sleeve outside airtight and inside vapour tight into the air resistance layer. Material must be provided by the customer. Consult your planner!
- **NOTICE:** Install the wall duct with a slope of $1 - 2^\circ$ to the exterior wall in order to ensure that occurring condensate may drain away.
- **NOTICE:** In order to prevent algae accumulation and a discolouration of the façade around the weather protection hood observe all installation advices (apply all sealing tapes!). In vulnerable areas, apply a biocidal/water repellent treatment to the plaster surface around the weather protection hood before installing. Consult your planner!
- If your device has a defect, contact your nearest distributor or our technical service.



Any kind of use other than the intended use will exclude all liability claims.

Improper use

Any use that is not mentioned in the intended use section, is considered to be improper.

Do not install the equipment in areas which...

- Contain (or may contain) strong oils or lubricants or extreme dusts.
- Contain (or may contain) flammable gases, liquids or vapours.

Do not use the ventilation unit for drying out buildings and must be sealed against dust until after all construction works are complete..

Qualified personnel

The inVENTer PAX complies with the applicable technical safety requirements and standards for household and similar electrical appliances. It may only be installed, set up and operated in conjunction with this documentation. Installation, electrical connection and set up of the equipment may only be performed by qualified personnel.

Qualified personnel within the meaning of the safety notices in this documentation are persons who are authorised to install, put it into operation and identify equipment, systems and circuits in accordance with established safety procedures.

2 System overview

The inVENTer PAX ventilation system is designed for ventilating small dwellings, bungalows, attics, residential homes and nursing homes, hotels and B&Bs, as well as bathrooms and utility rooms. Furthermore, the ventilation system is a special solution in the case of greater need for sound insulation, increased wind pressure and for buildings with thin walls. It is suitable for installation in new buildings as well as for retrofitting in existing buildings.

The inVENTer PAX standard set consists of the following components:

- Main module with user interface
- Infrared remote control
- Wall duct (2 x insulated wall sleeve, 60 cm length)
- Dust filter for outdoor air and extract air
- Silencer
- Plug-in connector
- PAX weather protection hood

The main module is installed as standard inside the extract air room on the inside of the exterior wall. Over a wall duct inside the exterior wall it is connected to the exhaust air and outdoor air. If it is not possible to mount the main module directly on the inside of an external wall, the outside air and exhaust air ducts must be made impermeable on site. Under certain conditions the inVENTer PAX can be installed in the subceiling.

In order to ensure that the device does not interfere with other ventilation processes and that its functioning is not affected by them, it must always be installed in its own wall sleeve. This must not contain any obstructions or other objects that interfere with the airflow.

The ventilation system can supply several rooms simultaneously. A duct system to bypass inside rooms and/or connect additional rooms is available as an option from inVENTer GmbH. Note that the specifications of the airflow-pressure curve refer to the standard set. If the main module is connected to an duct system, the air flow is reduced. Real values may be evaluated based on the airflow-pressure curve.

Under certain conditions the inVENTer PAX can be installed over the roof. This must be realised on site.

Features

- Tailor-made solution for a pleasant ambience in offices, living rooms and bedrooms as well as bathrooms and utility rooms.
- Power savings due to integrated cross-flow heat exchanger.
- Integral G4 dust filters for outdoor and extract air.
- Suitable for wall thicknesses between 100 mm and 600 mm.
- Different operating modes for an individual ambient climate.
- Regulation of supply and exhaust air.
- Heat recovery with supplementary heating.

2.1 Construction

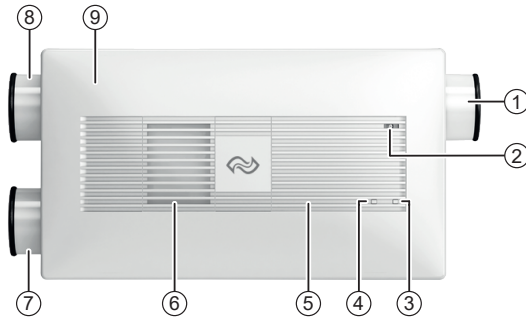

- 1 Supply air outlet
- 2 Infrared remote control receiver
- 3 ON/standby indicator light
- 4 Filter change indicator light
- 5 User interface grille cover
- 6 Extract air inlet
- 7 Exhaust air outlet
- 8 Outdoor air inlet
- 9 Front panel

Figure 1: Front view inVENTer PAX main module

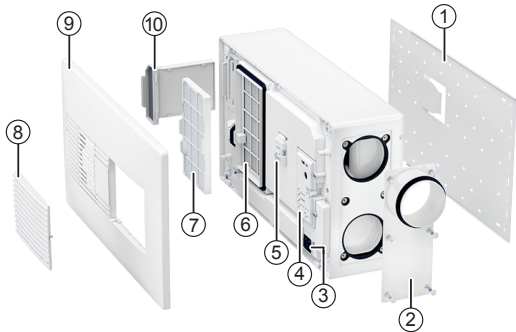

- 1 Mounting plate
- 2 Supply air adaptor
- 3 Main ON/OFF switch
- 4 User interface
- 5 Lever to release front panel
- 6 Opening for the extract air filter cartridge
- 7 Cartridge for extract air dust filter
- 8 User interface grille cover
- 9 Front panel
- 10 Outdoor air dust filter

Figure 2: Exploded view of the inVENTer PAX main module

Figure 3: Exterior closure: PAX weather protection hood with wall duct

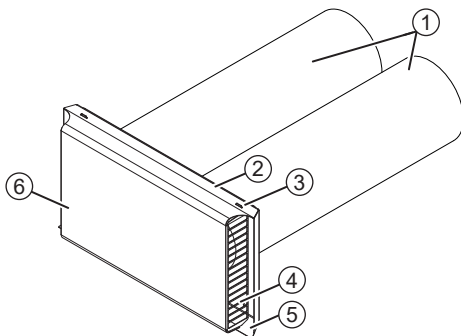

- 1 Wall duct (2x, 60 cm length)
- 2 Weather protection hood base plate
- 3 Fastener for weather protection hood cover (4 x)
- 4 Protective grid
- 5 Drip rail
- 6 Weather protection hood cover

2.2 Function

The inVENTer PAX ventilation system is equipped with an integral cross-flow heat exchanger. It stores the thermal energy from the indoor air (extract air) inside the main module and uses it to warm up the incoming outdoor air. Thus, the inflowing air is heated up before entering the room. A heating system is switched on at very low outside temperatures in order to avoid icing/condensation.

Heat recovery in conjunction with regulation of indoor humidity reduces air-conditioning costs.

If the outside temperature falls below $-30\text{ }^{\circ}\text{C}$, the ventilation unit switches off automatically.

Airflow and humidity are regulated and the operating mode selected via the remote control or the user interface directly on the main module.

Setting and autocalibrating the airflow

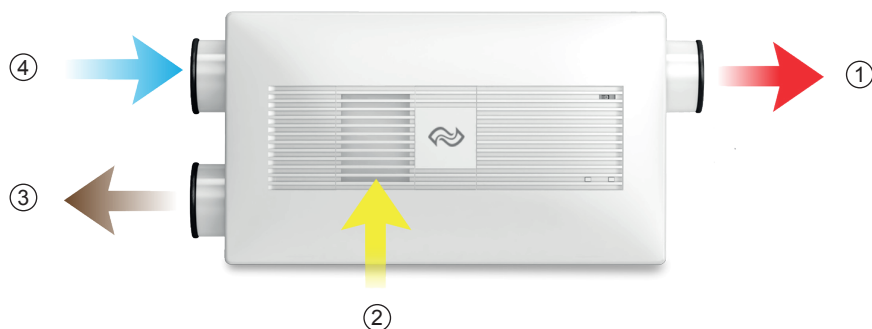

Figure 4: Airflow on the inVENTer PAX main module

- | | |
|---------------|---------------|
| 1 Supply air | 3 Exhaust air |
| 2 Extract air | 4 Outdoor air |

The air flow rate can be changed in three operating levels:

- Low airflow: 30 m³/h
- Moderate airflow: 52 m³/h
- High airflow: 78 m³/h

Balanced control of the air flow rates (low, moderate, high) is achieved by autocalibrating the unit. The fan runs at maximum speed for 60 min. to stabilise the temperature. Once calibration is complete, the settings are stored and the ventilation unit returns to the previous operating mode. Make sure that windows and doors are closed while autocalibrating the airflow.

Note that autocalibration only is carried out fault-free, if the ventilation system is mounted properly (each unit with its own outdoor air inlet and supply air outlet).

Setting the relative indoor air humidity (Dehumidification)

The ventilation unit can reduce excessive humidity to a specified level in enclosed spaces. Dehumidification can be set to 9 levels between 40 and 88 % indoor air humidity. The selected dehumidification level is displayed on the main module's user interface by a status indicator. Each of the status indicators displays one third of the range between 40 and 88 % indoor air humidity. Each level changes the sensitivity of the humidity sensor by 6 %.

When the selected humidity level is reached, the ventilation unit switches to extract air mode with maximum airflow. If humidity falls below the set value again, the ventilation unit initially continues to operate for 20 min in extract air mode with maximum airflow to stabilise the indoor air humidity level. It then switches back to normal mode with heat exchange.

Relative humidity is higher both indoors and outdoors during the summer months. To prevent the ventilation unit switching to extract air mode in the event of elevated humidity, the dehumidification level (percentage indoor air humidity) should be increased.

Operating modes

The ventilation unit inVENTer PAX provides four operating modes. Functional scope within the operating modes depends on the outside temperature. The following list provides an overview of the possible operating modes and the ventilation unit's functionality at different temperatures.

Mode	Outside temperature [°C]	Functionality
Normal	35 to -15	Continuous operation with heat exchange.
	-15 to -20	Extract air mode.
	-20 to -30	Extract air mode with air flow rate of 30 m³/h.
	below -30	Standby. Exhaust air outlet and outdoor air inlet closed.
Summer ¹⁾	≥ 10	Increased comfort in summer-time. If Mode Summer is on and the outdoor air is 4°C colder than the exhaust air, the supply air stops and the unit only works with exhaust air. If the outdoor temperature falls below 10°C Mode summer is deactivated automatically and the ventilation unit works in Mode Normal.
Eco	35 to -20	Continuous operation with heat exchange and minimal supplementary heating to prevent icing/condensation.
	-20 to -30	Extract air mode with airflow rate of 30 m³/h.
	below -30	Standby. Exhaust air outlet and outdoor air inlet closed.
Comfort	18 to -20	Continuous operation with heat exchange and supplementary heating to keep the supply air temperature above 18 °C.
	-20 to -30	Extract air mode with airflow rate of 30 m³/h.
	below -30	Standby. Exhaust air outlet and outdoor air inlet closed.

¹⁾ For optimal function of this operating mode we recommend an external air supply.

2.3 Control elements

Infrared remote control

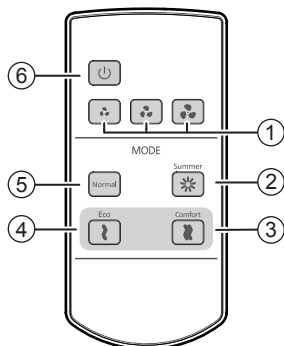

- 1 Fan button for setting the flow rate
- 2 Operating mode SUMMER button
- 3 Operating mode COMFORT button
- 4 Operating mode ECO button
- 5 Operating mode NORMAL button
- 6 ON/OFF button

Figure 5: Front view: Infrared remote control for inVENTer PAX

The remote control is a handheld electronic unit for controlling the core functions of the inVENTer PAX ventilation unit. It is based on infrared technology and depends on optical connection with the main module.

The remote control allows switching the unit on and off as well as choosing an operating mode by pressing the relevant symbol. Additionally, the airflow can be set.

User interface

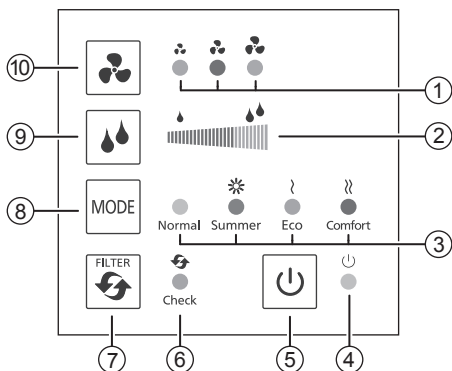

- 1 Airflow LEDs
- 2 Dehumidification status indicator
- 3 Operating mode indicator
- 4 Operation indicator light (green)
- 5 ON/OFF button
- 6 Filter change indicator light (orange)
- 7 Filter change button (reset)
- 8 Operating mode button
- 9 Dehumidification button (9 levels)
- 10 Fan button (3 levels)

Figure 6: Front view: inVENTer PAX user interface

The user interface is located on the main module. The user interface is an electronic programming unit for controlling all the functions of the inVENTer PAX ventilation unit.

In addition to the functions selectable by remote control it offers the possibility to set the limit value of relative humidity, set the filter change interval, and autocalibrates the airflow.

3 Preparing for installation

3.1 Installation advices



- The ventilation unit is connected directly to the 230 V AC mains. Installation and electrical connection must only be carried out by qualified personnel.
- Before installation, carefully read the sections installation and electrical connection to avoid installation errors.
- Before installing the wall duct, cut the folded spiral-seam ducts to a size of the wall thickness + 10 mm. After cutting to size, insert the folded spiral-seam ducts into the insulating sleeves. Ensure that the folded spiral-seam ducts terminate with the insulating sleeves at the room interior end.

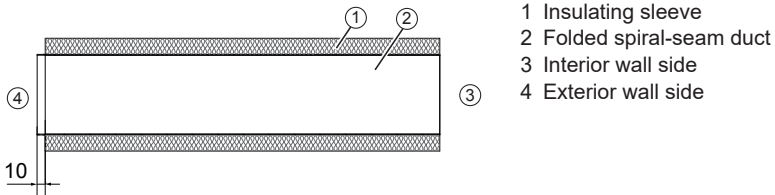

- The inVENTer PAX ventilation system can be installed over several rooms. If the main module is connected to an duct system, the air flow is reduced. Real values may be evaluated based on the airflow-pressure curve (page 39). Note that the specifications of the airflow-pressure curve refer to the standard set.
- Observe the predetermined minimum distances on both sides of the wall (see dimensional drawing):
 - 1 Minimum distance to adjacent components on the exterior wall: 250 mm from hole center
 - 2 Minimum distance to adjacent components on the interior wall: 85 mm from hole center
 - 3 Distance between exhaust air outlet and outdoor air inlet: 170 mm
 - 4 Minimum distance between two ventilation units to avoid the mixing of outdoor air and exhaust air. 1.20 m
- Connect each ventilation unit to its own outdoor air inlet and supply air outlet.
- Install the wall duct outside airtight and inside vapour tight into the air resistance layer. Material must be provided by the customer.
- The volume of supply air should match the volume of extract air. We recommend an external air supply for inVENTer PAX. This may be realised by appropriate overflow measures: An air gap of about 10 mm below the door, unscrew the hinges by 5 mm, use a ventilation grille or similar.
- The ventilation unit must not be used for drying out buildings and must remain sealed against dust during the construction work. It must not be put into operation until after completion of the construction work.

3.2 Dimensions

Designation	Depth/length [mm]	Width [mm]	Height [mm]	ø [mm]
Wall opening for exhaust air	Wall thickness ¹⁾	–	–	160
Wall opening for outdoor air	Wall thickness ¹⁾	–	–	160
Wall opening for supply air	Wall thickness	–	–	110
PAX weather protection hood ²⁾	52	398	214	–

¹⁾ incl. render, insulation, masonry and inner structure.

²⁾ optional in vertical alignment

3.3 Installation situation inVENTer PAX standard set

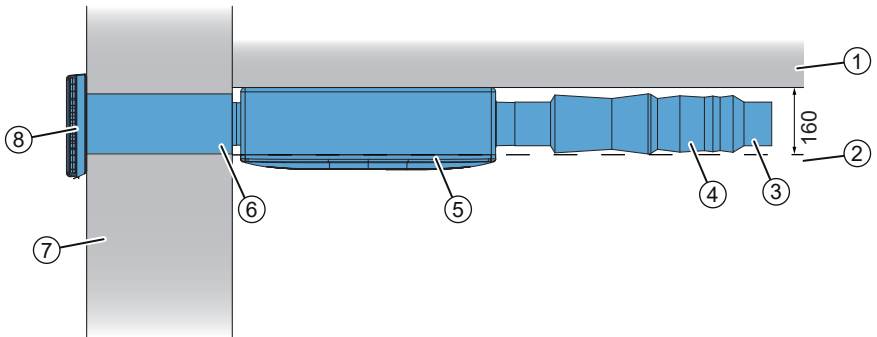

Figure 7: InVENTer Pax standard set installed (horizontal alignment)

- | | |
|---|---------------------------|
| 1 Ceiling (interior) | 5 Main module |
| 2 Suspended ceiling
(may be realised as an option) | 6 Wall duct |
| 3 Plug-in Connector | 7 Exterior wall |
| 4 Silencer | 8 Weather protection hood |

PAX weather protection hood

The PAX-h weather protection hood in horizontal alignment is the standard exterior closure for the inVENTer PAX ventilation system. On request the PAX weather protection hood is available in vertical alignment.

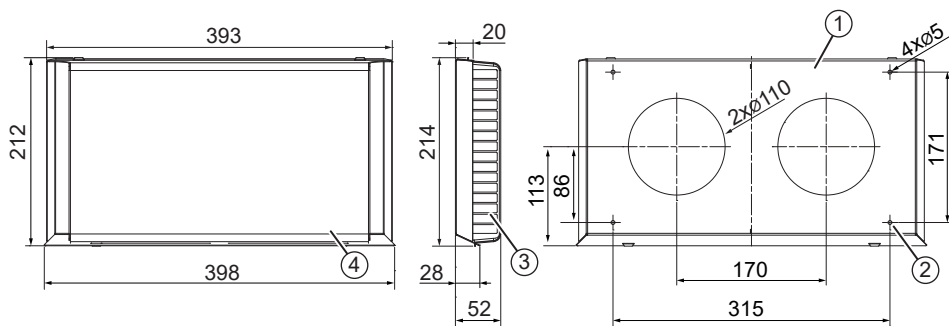

Figure 10: Dimensional drawing PAX weather protection hood

- | | |
|--------------------------------------|---------------------------------|
| 1 Weather protection hood base plate | 3 Protective grid |
| 2 Exterior wall attachment points | 4 Weather protection hood cover |

3.5 Installation conditions for connection over the roof

Under certain conditions the ventilation unit may be combined with an exterior closure over the roof.



NOTICE

Ventilation system installed/connected wrong over the roof.

Damage and/or malfunction of the inVENTer PAX ventilation system!

- Observe installing conditions for the connection over the roof.

Observe the following installation conditions to avoid damages to the product:

- The roof hoods must overtower the local snow depth and be carried out driving rain resistant.
- Insulate the outdoor and exhaust air ducts according to applicable rules of engineering impermeable. Thus, due to cold outdoor temperature occurring condensate at the outer side of the outdoor duct and the exhaust duct is prevented.
- Install a condensate reservoir or condensate line according to applicable rules of engineering to discharge occurring condensate inside the outdoor duct and the exhaust duct.
- Install the roof hoods with a minimum distance of 1.2 m to avoid the mixing of outdoor air and exhaust air.

4 Assembly and installation

4.1 Check the scope of supply

Check the delivery for completeness and transport damage upon receipt using the delivery note. Report missing items immediately, and at the latest within 14 days to your supplier, distributor or factory representative.

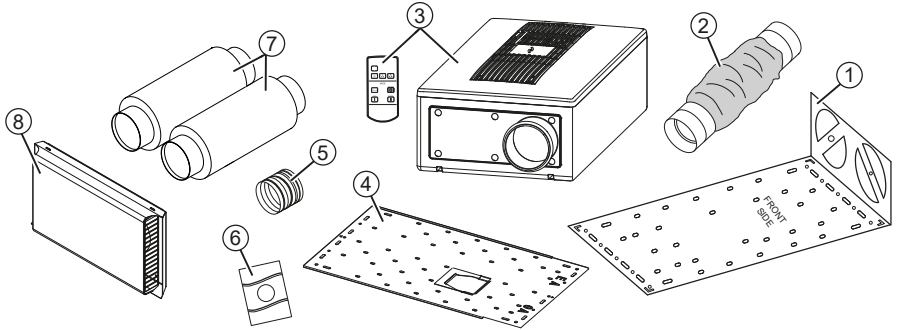

Figure 11: inVENTer PAX standard set

- | | |
|-----------------------------------|---|
| 1 Drilling template | 5 Plug-in connector |
| 2 Silencer | 6 Installation and operating instructions |
| 3 Main module with remote control | 7 Wall duct |
| 4 Mounting plate | 8 Weather protection hood |

4.2 Create wall opening/drill holes



DANGER

There must be no electrical wires laid beneath the location of the planned drill holes.

Electric shock and injury due to live components (230 V, 50 Hz)!

- ▶ Before creating wall openings, check for cables and wires laid beneath the plaster.



CAUTION

Falling masonry when creating the wall opening.

Injury to persons and/or damage to property!

- ▶ Use adequate protection against falling masonry.
- ▶ Remove objects from the immediate vicinity.



Milling drill with \varnothing 160 mm, drilling bit \varnothing 8 mm, wall chaser, adhesive tape, marker pen

Requirements:

The masonry must be dry and in a load-bearing condition.

There must be no load-bearing elements at the location of the planned wall openings.

- ▶ Secure the drilling template to the ceiling with adhesive tape.
- ▶ Mark the position of the mounting plate at the corners of the drilling template (red circles).
- ▶ Mark the position for the drill holes:
 - 6 oblonged holes for fastening the main module (freely selectable, preferably on outer edge).
 - 2 bore holes for the wall opening centers.

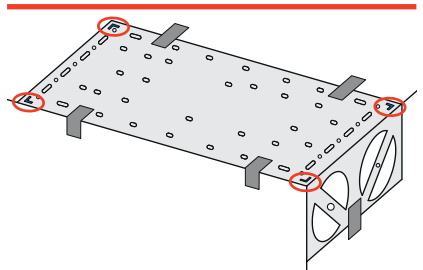

- ▶ Remove the drilling template.
- ▶ Drill the 8 holes with \varnothing 8 mm, min. 50 mm deep to the ceiling and interior wall.

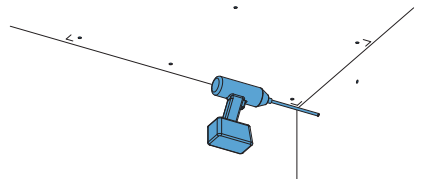

- ▶ Create 2 wall openings for the wall duct.

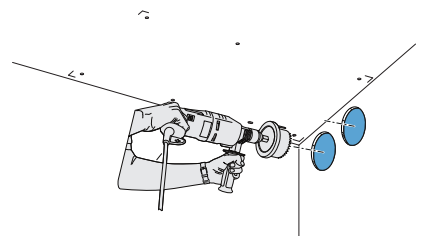

⇒ The wall openings and bore holes are created.

4.3 Install the mounting plate



CAUTION

Falling main module.

Injury to persons and/or damage to property!

- ▶ Verify the load-bearing capacity of the ceiling/interior wall.



Rawl plugs, screws, screw driver

Requirements:

Boreholes are drilled.

Ceiling/interior wall must be dry and in a load-bearing condition.

- ▶ Insert the rawl plugs into the boreholes on the ceiling.

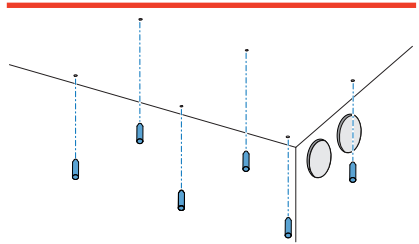

- ▶ Screw the mounting plate to the interior wall with 6 screws.
Makes sure that the designations EA (extract air) and OA (outdoor air) are readable and located in direction of the wall openings.

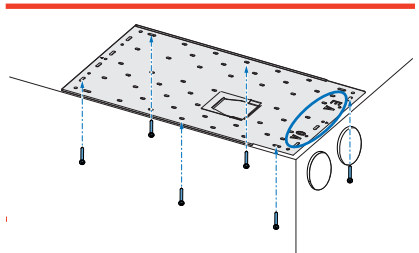

⇒ The mounting plate is installed.

4.4 Insert the wall ducts



NOTICE

Accumulation of condensate in the wall duct and interruption of the thermal insulation composite system.

Damage to exterior wall/masonry and the building structure.

- ▶ Attach the wall ducts with a slope of 1 – 2° to the exterior wall.
- ▶ Replace the wall construction as far as the wall ducts.
- ▶ Observe the necessary barrier levels.



Non-pressing 2K fitting foam, cutter

Requirements:

The wall openings \varnothing 160 mm are created.

- ▶ Determine the exact wall thickness X .
Be sure to add the thickness of exterior render, insulation, masonry and interior plaster.
- ▶ Cut the folded spiral-seam ducts to a size of the wall thickness $X + 10$ mm.
- ▶ Cut the insulating sleeves to a size of the wall thickness X .
- ▶ Insert the folded spiral-seam ducts into the insulating sleeves.
Make sure that the folded spiral-seam duct is flush with the insulating sleeve on one side.

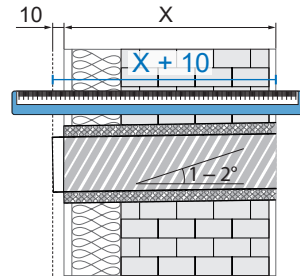

- ▶ Insert the wall ducts into the wall openings from the interior.
Ensure that the wall ducts are flush with the interior wall.

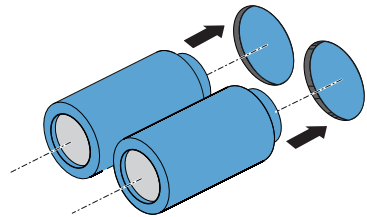

- ▶ Cut off the insulating sleeves flush with the exterior wall using a knife.
Ensure that the folded spiral-seam ducts do not end flush with the exterior wall.

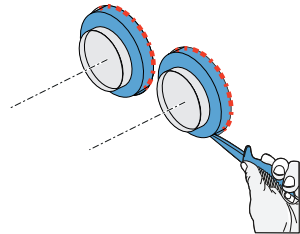

- ▶ Fill the gap between the insulating sleeve and the masonry on the exterior and interior wall with non-pressing fitting foam.

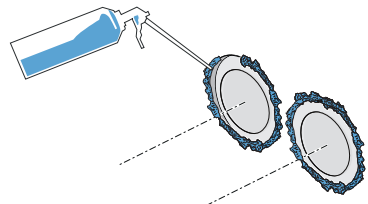

⇒ The wall duct is inserted.

4.5 Mount the main module



DANGER

Exposed electrical components.

Electric shock and injury due to live components (230 V, 50 Hz)!

- ▶ Before working on electrical installations, disconnect affected equipment from the power supply.
- ▶ Observe the requirements for protection class II when laying the mains cable.
Do not lay or connect live cables.
- ▶ Installation and electrical connection must only be performed by qualified and trained personnel.



Screws, end caps for screws, ecrew driver, sealing tape, adhesive tape, permanently elastic sealing compound, 200 mm long-bit PH2

Requirements:

The wall duct is mounted.

The mounting plate is installed.

- ▶ Lay the power cable, 230 V AC, to the mounting plate for the main module.



NOTICE

No sealing tape.

Reduction in airflow!

- ▶ Fit sealing tape to the casing on the outdoor air/exhaust air adaptor side.

- ▶ Attach the sealing tape circumferentially around the outdoor air/exhaust air adaptor to the main module.
- ▶ Attach sealing tape between both adaptors on the main module.
- ▶ Turn the main module to the supply air side.

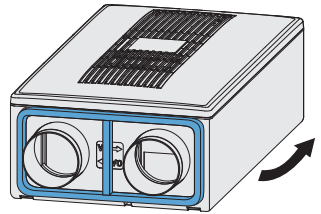

- ▶ Align the supply air adaptor to the position of the supply air ducts.
- ▶ Screw the supply air adaptor to the main module with 6 screws.
- ▶ Cover the screws with 6 end caps.

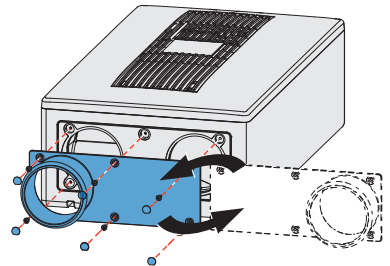

ASSEMBLY AND INSTALLATION

- ▶ Press down the grille cover on the supply air adaptors side.
⇒ The grille cover is unclipped.

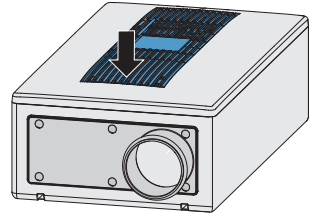

- ▶ Fold the grille cover upwards (1).
- ▶ Slide the lever (red arrow) on the casing sideways (2).
⇒ The front panel is released.

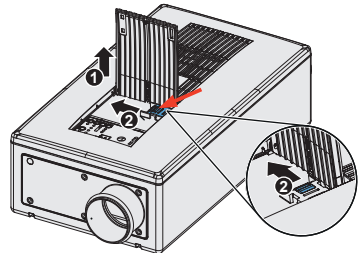

- ▶ Unclip the front panel from the roller catches on both sides.
- ▶ Pull up and remove the front panel.

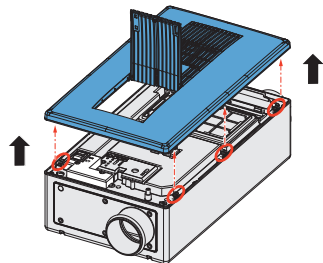

- ▶ Remove the screws from the terminal box cover.
- ▶ Detach the terminal box cover.

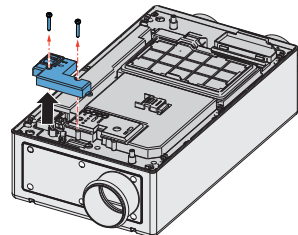

- ▶ Turn the main module on its side (1).
- ▶ Lead the power cable through the main module to the terminal box on the main module's opposite side (2,3).
Ensure that the power cable is long enough for connection.

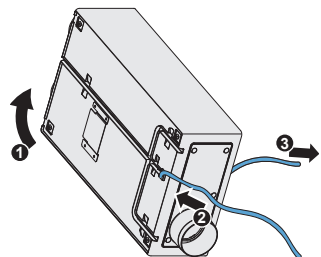



TIP: Three cable conduits are located on the back of the main module for different ways of laying the power cable to the unit's electrical connection.

- ▶ Lay the power cable inside one of the cable conduits.
- ▶ Affix the power cable inside the selected cable conduit with adhesive tape.
- ▶ Seal the cable entry (red arrow) with permanently elastic sealing compound.

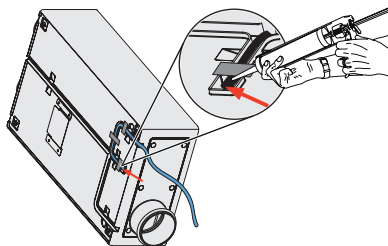

CAUTION

Falling main module.

Injury to persons and/or damage to property!

- ▶ Screw the main module to the mounting plate.



NOTICE

Displacement of the Folded spiral-seam ducts in the wall duct.

Leakage air flow and/or condensate penetration into insulating sleeves!

- ▶ Fix the folded spiral-seam ducts by applying counter pressure from the outside.

- ▶ Press the main module against the mounting plate.
- ▶ Push the main module towards the wall duct.
- ▶ Snap the catch on the mounting plate into place in the corresponding slot on the main module's base.

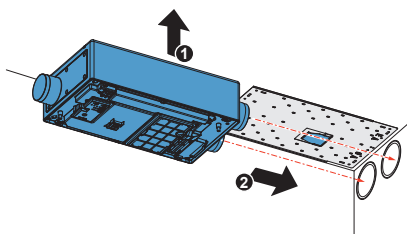

- ▶ Screw the main module to the mounting plate with 4 screws using the supplied 200 mm bit PH2.

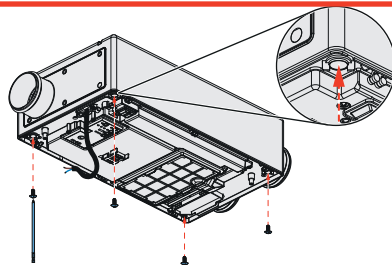

⇒ The main module is installed.

4.6 Connect the main module



DANGER

Exposed electrical components.

Electric shock and injury due to live components (230 V, 50 Hz)!

- ▶ Before working on electrical installations, disconnect affected equipment from the power supply.
- ▶ Do not lay or connect live cables.
- ▶ Installation and electrical connection must only be performed by qualified and trained personnel.



TIP: The ventilation unit is equipped with an internal ON/OFF switch (circuit breaker), which disconnects all poles of the unit from the power supply in accordance with overvoltage category III. The ON/OFF switch forms part of the hard wiring in the unit in accordance with the applicable regulations. We recommend installing a separate power circuit with circuit breaker for the ventilation unit.

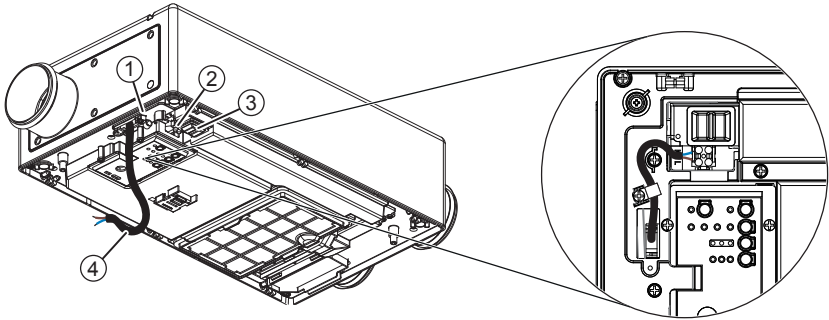

Figure 12: Electrical connection of the inVENTer PAX main module.

- | | |
|-------------------|-----------------------|
| 1 Stain relief | 3 Main ON/OFF switch |
| 2 Lustre terminal | 4 Power cable, 2-pole |

The inVENTer PAX is connected directly to the 230 V AC mains. Electrical connection takes place inside the main module's terminal box.

Requirements:

The main module is installed. The power supply is disconnected.

- ▶ Cut the power cable to size (Dismantling: 7 mm).
- ▶ Connect the power cable, 230 V AC, to the lustre terminal inside the terminal box.

Power cable		Lustre terminal
Terminal	Colour	Terminal
Phase	brown	L
Neutral conductor	blue	N

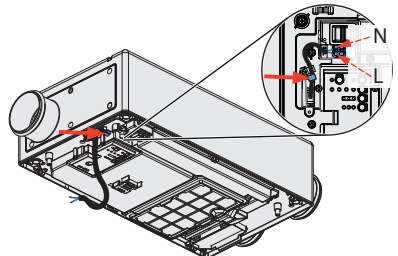

- ▶ Secure the power cable with the cable stain relief (red arrow) to the casing.

- ▶ Reattach the terminal box cover.
- ▶ Screw the terminal box cover to the main module with 2 screws.

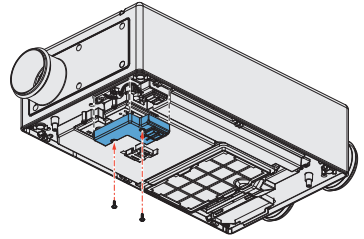

- ▶ Press the main ON/OFF switch into position I.
⇒ The ventilation unit is switched on.

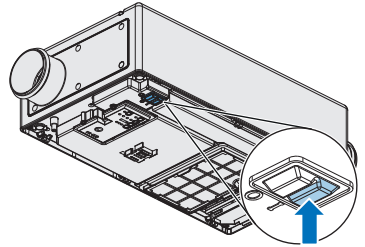

- ▶ Snap the front panel into place in the roller catches (red marking) on both sides of the casing.

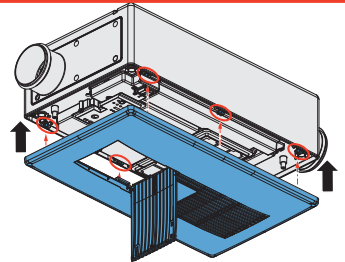

- ▶ Slide the lever (red arrow) on the casing sideways (1).
⇒ The front panel is locked.
- ▶ Fold the grille cover upwards until it snaps in (2).

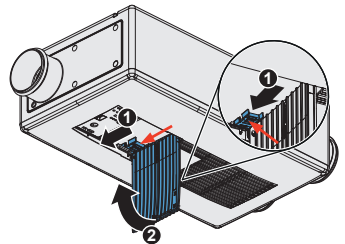

⇒ The main module is connected.

4.7 Mount the weather protection hood

The PAX weather protection hood in horizontal alignment is the standard exterior closure for the inVENTer PAX ventilation system. For mounting the weather protection hood in vertical alignment see the instructions attached to the weather protection hood.



NOTICE

Mounting the weather protection hood on unfinished exterior wall.

Damage to the exterior wall!

- ▶ Only mount the weather protection hood when the exterior wall is completed and fully cured.



NOTICE

Penetration of condensation water and/or algae accumulation around the weather protection hood.

Damage to the external wall and masonry and/or discolouration of the facade!

- ▶ Before installation of the weather protection hood apply all sealing tapes circumferentially.
- ▶ In vulnerable areas, apply a biocidal/water repellent treatment to the plaster surface around the weather protection hood before installing (Consult your planner!).



Spirit level, marker pen, drilling machine with drilling bit \varnothing 8 mm, screw driver, rawl plugs (wall plugs for insulation when exterior wall is insulated), permanently elastic outdoor sealing compound

Requirements:

The exterior wall is finished and even.

The wall duct is inserted and shortened.



NOTICE

Drip rails on weather protection hood aligned incorrectly.

Damage to the exterior wall and masonry!

- ▶ Observe correct alignment of drip rails to the top and bottom.

- ▶ Place the base plate onto the wall duct from the exterior.

Ensure that the openings on the base plate are centrally aligned over the wall duct.

Ensure that the drip rail is positioned to the bottom.

- ▶ Level the base plate using a spirit level.
- ▶ Mark the 4 drill holes (red arrows).
- ▶ Drill the 4 holes with \varnothing 8 mm, min. 50 mm deep.
- ▶ Insert the rawl plugs.

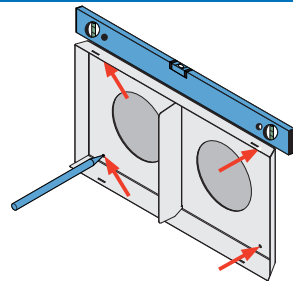

TIP: When fitting the base plate for the PAX weather protection hood on exterior walls with thermal insulation, use wall plugs for insulation for a secure hold. These are not part of the scope of supply, but are available as an option.



TIP: Fit the sealing tape only immediately prior to installing the weather protection hood. This prevents the complete swelling of the sealing tape which makes the installation easier.

- ▶ On the base plate's exterior wall side, attach the 9 mm sealing tape circumferentially
 - on the outer edge.
 - flush with the openings for the wall duct.**Ensure that the sealing tape does not protrude the openings.**

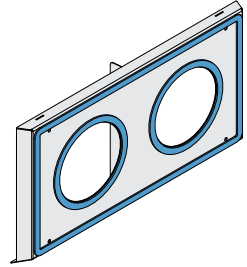

- ▶ Screw the base plate to the exterior wall with four screws.

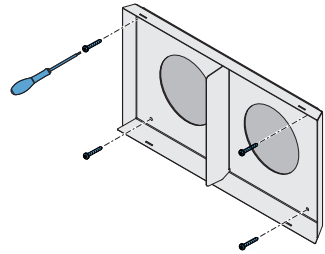

TIP: The tabs to clip in the weather protection hood cover on each side have different distances. When fitting the cover, the the with the greater distance are facing to the top.

- ▶ Hook the cover from the underneath into the upper drip rail's slots (red arrows).
- ▶ Fold the cover towards the base plate.
- ▶ Snap the tabs on the cover into the bottom drip rail's slots.

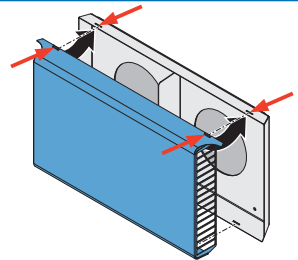

- ▶ Seal the joint between the cover of the weather protection hood and the exterior wall at the sides and top with a permanently elastic outdoor sealing compound.

⇒ The Pax weather protection hood is mounted.

5 Operation



CAUTION

Operation by children and persons with limited abilities.

Injury to persons and/or incorrect functioning of the ventilation system!

- ▶ Operation of the device must not be carried out by children and/or persons who are not fully capable of doing so due to their physical, sensory or mental capabilities, inexperience or lack of knowledge.

5.1 Open grille cover

Requirements:

The ventilation unit is switched off.

- ▶ Press the grille cover on the front panel (side where indicator lights are located) upwards until it unclips.
- ▶ Fold the grille cover downwards.

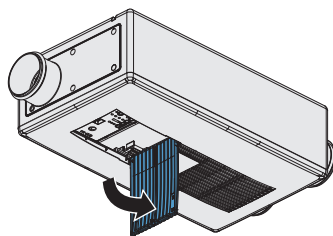

⇒ The grille cover is unclipped. You have access to the user interface.

5.2 Operating the ventilation unit via user interface on the main module

1 Starting/ Setting standby the ventilation unit	Page 28
2 Setting the operating mode	Page 29
3 Setting the flow rate	Page 29
4 Autocalibrating the airflow	Page 29
5 Setting the dehumidification	Page 30
6 Setting to default	Page 30

Starting/Setting standby the ventilation unit

Requirements:

The ventilation unit is in standby/started. The grille cover is unclipped (see section 5.1).

- ▶ Press the button .
 - ⇒ The operating mode indicator light is illuminated.
 - ⇒ The ventilation unit is started.
- ▶ Press the button once again.
 - ⇒ The operating mode indicator light extinguishes.
 - ⇒ The ventilation unit is in standby.

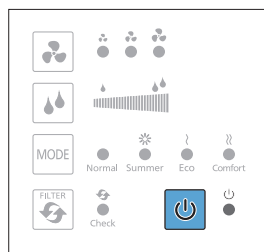

⇒ The ventilation unit is started/in standby.

Setting the operating mode

Requirements:

The ventilation unit is switched on. The grille cover is unclipped (see section 5.1).

- ▶ Press the button  repeatedly until the indicator light of the desired operating mode is lit.

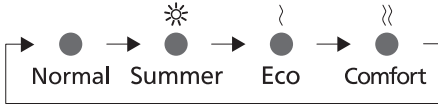

⇒ The operating mode is set.

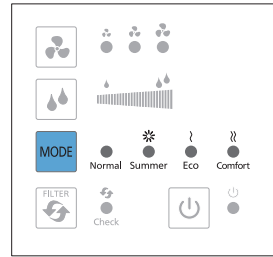

Setting the flow rate

Requirements:

The ventilation unit is switched on. The grille cover is unclipped (see section 5.1).

- ▶ Press the button  repeatedly until the indicator light of the desired flow rate is lit.

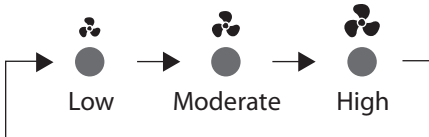

⇒ The flow rate is set.

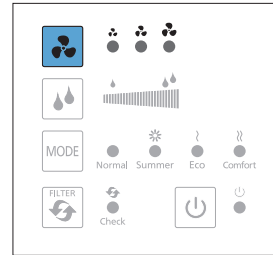

Autocalibrating the airflow

When changes to the inVENTer PAX ventilation system are made or new installation is made the airflow is not adapted. After changes/installation, carry out an autocalibration to adjust the ventilation systems to the changed parameters.

Requirements:

The ventilation unit is switched on. All doors and windows are closed.

The grille cover is unclipped (see section 5.1).

- ▶ Press the button  for 3 seconds.
 - ⇒ Automatic regulation of airflow is started.
 - ⇒ Operating mode indicator light flashes.
 - ⇒ Once calibration is complete, the last selected operating mode is displayed again.

⇒ Airflow is calibrated.

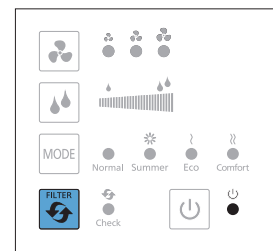

Setting the dehumidification

The inVENTer PAX ventilation unit is supplied with a factory default dehumidification level of 58 % indoor air humidity. Dehumidification can be adjusted to 9 levels between 40 and 88 % indoor air humidity. Each level changes the sensitivity of the humidity sensor by 6 %.

Requirements:

The ventilation unit is switched on. The grille cover is unclipped (see section 5.1).

- ▶ Press the button  repeatedly.
 - ⇒ Dehumidification indicator light illuminates on user interface.
 - ⇒ The more indicator lights are illuminated, the higher the dehumidification level.

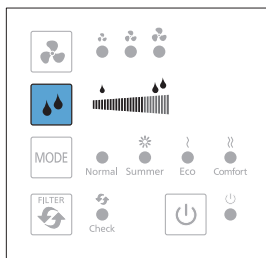



⇒ Dehumidification is set.

Setting to default

The settings for airflow rates and air dampers can be restored to factory default.

Requirements:

The ventilation unit is in standby. The grille cover is unclipped (see section 5.1).

- ▶ Press the buttons  and  simultaneously for 10 seconds.
 - ⇒ A buzzer sounds.

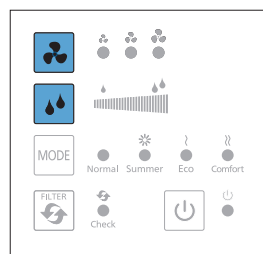

⇒ Factory defaults have been restored.



5.3 Operating the ventilation unit with infrared remote control

The remote control for inVENTer PAX works on the principle of infrared. Make sure that you are within reach of the main module and no objects are in the way.

Starting/Setting standby the ventilation unit

Requirements:

The ventilation unit is in standby/started.

- ▶ Press the button .
 - ⇒ The ventilation unit is started.
- ▶ Press the button  once again.
 - ⇒ The ventilation unit is in standby.







⇒ The ventilation unit is started/in standby.

Setting the operating mode

Requirements:

The ventilation unit is switched on.

- ▶ Press the button with the symbol matching the desired operating mode:

-  Operating mode NORMAL
-  Operating mode SUMMER
-  Operating mode ECO
-  Operating mode COMFORT

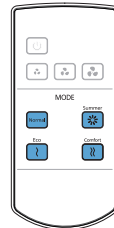



⇒ The operating mode is set.

Setting the flow rate

Requirements:

The ventilation unit is switched on.

- ▶ Press the button with the symbol matching the desired airflow:

-  Low
-  Moderate
-  High



⇒ The flow rate is set.

6 Cleaning and maintenance



CAUTION

Cleaning/maintenance by children and persons with limited abilities.

Injury to persons and/or incorrect functioning of the ventilation system!

- ▶ Cleaning and/or maintenance of the device must not be carried out by children and/or persons who are not fully capable of doing so due to their physical, sensory or mental capabilities, inexperience or lack of knowledge.

The inVENTer® PAX ventilation unit is virtually maintenance-free. Any necessary cleaning or maintenance work of the main module can be carried out by the user by following these instructions.

Cleaning and maintenance of the ducting system must be carried out by an installation company.



TIP: Before performing cleaning or maintenance tasks, disconnect the power supply on the main ON/OFF switch (see section 6.1).

Detergents



NOTICE

The surface of the ventilation unit is heat-sensitive and susceptible to scratching.

Damage to the surface!

- ▶ Do not use sand, soda, acid or chlorine-based cleaning agents.
- ▶ The water temperature for cleaning must be below 60 °C.

A commercially available detergent in warm water can be used for cleaning the front panel and the casing. The following tools may be used for cleaning:

- lint-free, soft cloth
- soft brush

Recommended maintenance

The maintenance tasks and intervals listed here are recommended by inVENTer GmbH to maintain the functionality and performance of the inVENTer PAX ventilation unit.

Depending on requirements and/or air quality, your personal maintenance plan may deviate from these recommendations.

Interval	Assembly	Maintenance activity
Quarterly	Ventilation unit casing	Clean the surface with a damp cloth.
As required	Filters	Replace the outdoor and extract air dust filter.
Yearly	Ducting	Cleaning of the ducting has to be carried out by an installation company.
Yearly	PAX weather protection hood	Clean the front panel with a damp cloth and clean between the grille with a soft brush.

6.1 Switching on/off the ventilation unit via main ON/OFF switch

Requirements:

The ventilation unit is switched on/off.

- ▶ Press the grille cover on the front panel (side where indicator lights are located) upwards until it unclips.
- ▶ Fold the grille cover down (1).
- ▶ Slide the lever (red arrow) on the casing sideways (2).
 - ⇒ The front panel is released.

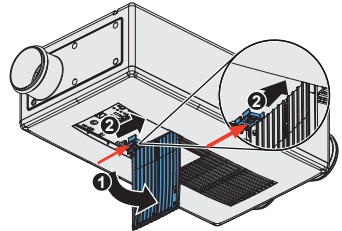

- ▶ Unclip the front panel from the roller catches on both sides.
- ▶ Pull down and remove the front panel.

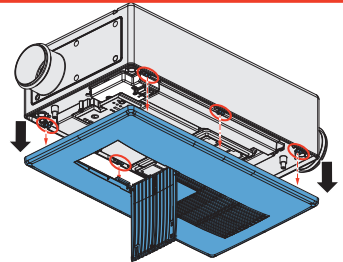

Switching on:

- ▶ Press the main ON/OFF switch into position I.
 - ⇒ The ventilation unit is switched on via the main ON/OFF switch.

Or

Switching off:

- ▶ Press the main ON/OFF switch into position 0.
 - ⇒ The ventilation unit is switched off via the main ON/OFF switch.

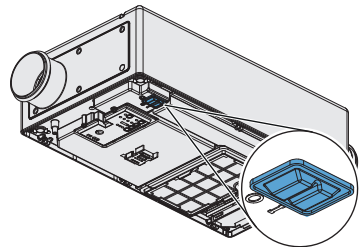

- ▶ Snap the front panel into place in the roller catches on both sides of the casing.

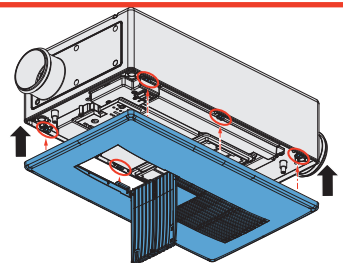

- ▶ Slide the lever (red arrow) on the casing sideways (1).
⇒ The front panel is locked.
- ▶ Fold the grille cover upwards until it snaps in (2).

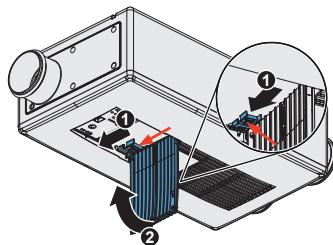

⇒ The ventilation unit is switched on/off via the main ON/OFF switch.

6.2 Setting the filter change interval

The degree of contamination of the filter is not captured automatically. Therefore set an interval according to your own observations.

Factory set a change interval of 180 days is preset. Depending on the indoor and outdoor air's contamination level the following change intervals may be set: 90, 180, 270, and 365 days.





TIP: The filter change interval may only be set via the main module's user interface. Setting by remote control is not possible.

Requirements:

The ventilation unit is switched on. The grille cover is unclipped (see section 5.1).

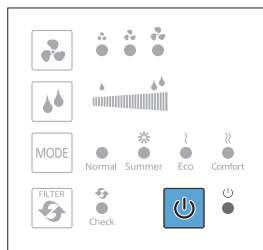
- ▶ Press the button.
 - ⇒ The operating mode indicator light extinguishes.
 - ⇒ The ventilation unit is in standby.





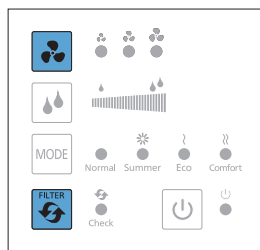



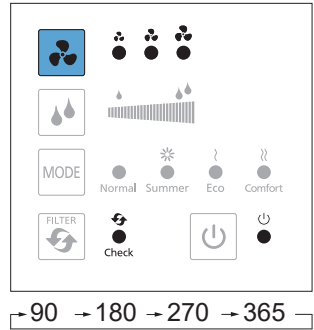

































- ▶ Press the buttons  and  simultaneously for 3 seconds.
 - ⇒ The buzzer sounds twice.
 - ⇒ The user interface is activated for setting the change interval.



- ▶ Press the button  repeatedly until you reach the required time interval.
 - ⇒ The buzzer sounds for each selected time interval.
 - ⇒ The currently selected time interval is indicated by the flashing airflow, filter and mode LEDs (see table below).



Status lights while setting the filter change interval:

Interval / Days	Indicator light		
	Flow rate LED	Filter change LED	Operating mode LED
90	     	 	 
180	     	 	 
270	     	 	 
365	     	 	 

- ▶ Press the buttons  and  simultaneously for 3 seconds.

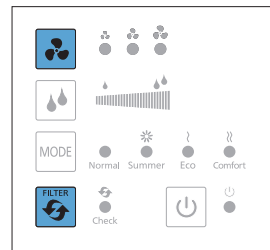

- ⇒ The filter change interval is set.

6.3 Replace the dust filters



NOTICE

Strong contamination of the outdoor and extract air filter.

Output and flow rate of inVENTer PAX are reduced!

- ▶ Observe filter change interval.
- ▶ When changing air filters, **both** the outdoor air and the extract air filter must be replaced.

Requirements:

The ventilation unit is switched off via the main ON/OFF switch (see section 6.1).

- ▶ Unclip locking bracket to the side.

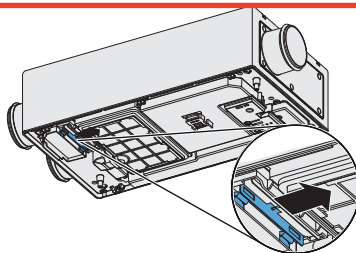

- ▶ Press together the tabs (red arrows) on the outdoor air filter cartridge.
⇒ The outdoor air filter cartridge unclips.
- ▶ Pull down the outdoor air filter cartridge (1).
- ▶ Remove the filter cartridge's cover.
- ▶ Replace the outdoor air filter.
- ▶ Insert the cover into the filter cartridge.

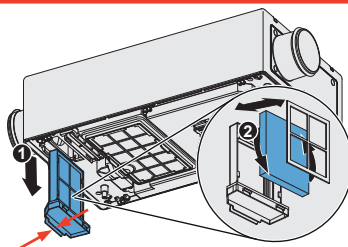

- ▶ Clean the opening for outdoor filter cartridge (e.g. with vacuum cleaner).
- ▶ Slide the outdoor air filter cartridge into the main module (1).
- ▶ Snap the locking bracket to the side to secure the filter cartridge.

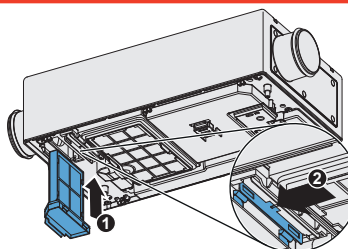

- ▶ Press together the tabs (red arrows) on the extract air filter cover.
- ▶ Pull down the extract air filter cover with filter.
- ▶ Clean the opening for extract air filter (e.g. with vacuum cleaner).

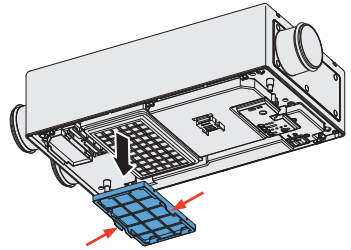

- ▶ Remove the contaminated filter.
- ▶ Insert the new filter into the cover for the filter cartridge.
- ▶ Insert the extract air filter cover into the main module (2).

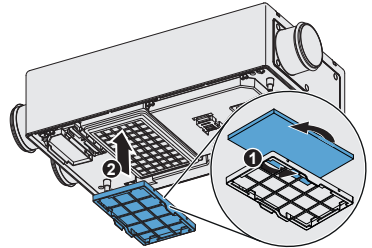

- ▶ Press the main ON/OFF switch into position I.
⇒ The ventilation unit is switched on.

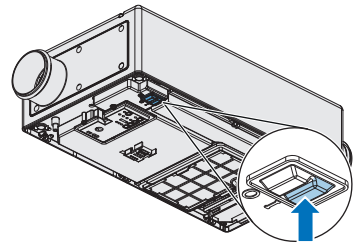

- ▶ Snap the front panel into place in the roller catches (red marking) on both sides of the casing.

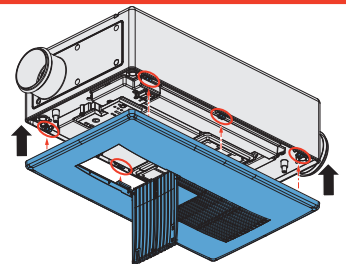

- ▶ Slide the lever (red arrow) on the casing sideways (1).
⇒ The front panel is locked.
- ▶ Fold the grille cover upwards until it snaps in (2).

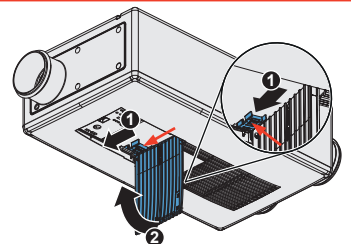

⇒ You have replaced the filters.

7 Specifications

Main module

Feature	Value			
Outside temperature [°C]	-30 – 35			
Indoor temperature [°C]	5 – 35			
Extract air/Outdoor air	Free from aggressive gases, dust and oils			
Type of protection	IP24			
Protection class	II			
Input voltage [V AC/Hz]	230/50			
Standard sound level differential [dB] (exhaust air area)	47			
Standard sound level differential [dB] (supply air area)	77			
	Output level			
	Low	Moderate	High	only ex- haust air
Airflow (free blowing) [m³/h]	30	52	78	90
Noise emission (rated) [dB (A)]	19	22	29	35
Power consumption [W]	3.5	8.0	18.0	25.0
Max. Power consumption with heating [W]	< 375	< 375	375	–
Heat recovery [η_{w}]	0.8	0.78	0.75	–
Leakage loss [%]	5			
Energy efficiency class	A			
Wall thickness with render [mm]	100 – 600			
Wall opening [mm]	2 x Ø 160			
Dimensions [W x H x D in mm]	720 x 340 x 191			
Weight [g]	9500			

Wall duct (Insulating sleeve with folded spiral-seam duct)

Feature	Value
Length/Diameter (single) [mm]	600/140
Weight [g]	2500

Silencer

Feature	Value
Depth [mm]	350 – 500
Duct/ Insulation [mm]	DN100/ x Ø 160
Weight [g]	500

PAX-h weather protection hood¹⁾

Feature	Value
Dimensions [W x H x D in mm]	398 x 214 x 52
Weight [g]	1210
Colour	White – RAL9016 Grey – RAL9006 Nord – RAL7011

¹⁾ On request the PAX weather protection hood is available in vertical alignment and/or custom colour.

Airflow curve inVENTer PAX

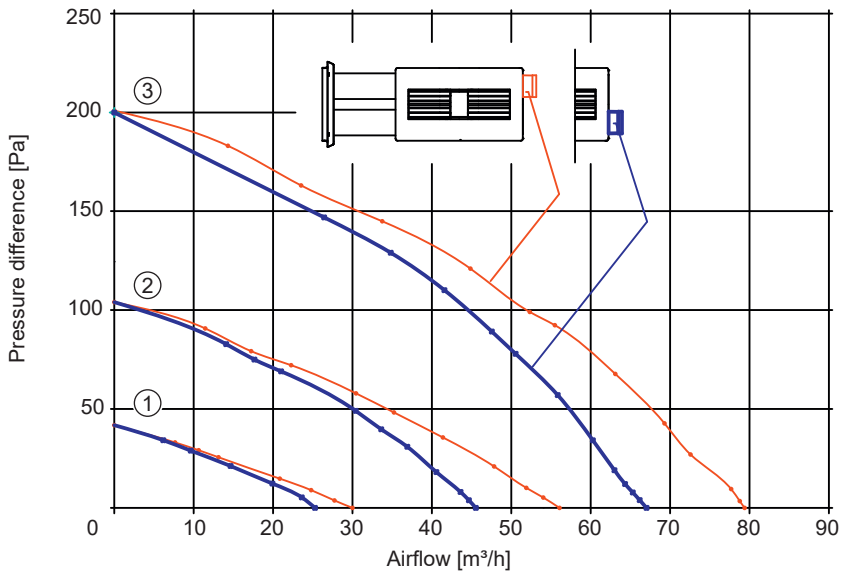

Figure 13: Airflow-pressure curve inVENTer PAX (free blowing)

- 1 Fan level 1
- 2 Fan level 2

- 3 Fan level 3

8 Scope of supply

Standard set

- inVENTer PAX main module w. remote control, mounting plate, drilling template, accessory kit
- Silencer, Plug-in connector, Wall duct (Insulating sleeve/folded spiral-seam duct)
- PAX-h weather protection hood (white, grey, Nord) w. accessory kit

Component	Order number
inVENTer PAX standard set	1001-3001
Installation and operating instructions	5015-0003

PAX-h weather protection hood¹⁾

Component	Order number
Weather protection hood PAX-h, white – RAL9016	1508-3001
Weather protection hood PAX-h, grey – RAL9006	1508-3002
Weather protection hood PAX-h, Nord – RAL7011	1508-0079

¹⁾ On request the PAX weather protection hood is available in vertical alignment and/or custom colour.

9 Accessories

Component	Order number
Folded spiral-seam duct DN100x995	1506-3002
Disc valve – supply air DN100, steel white	3006-3001
Silencer DN100, telescopic (380-500)	3008-3001
Plug-in adaptor DN100, lip seal	3008-3002
Plug-in socket DN 100	3008-3006
90° bend DN100, lip seal	3008-3007
Equal tee DN100, lip seal	3008-3008
End cover duct DN100	3008-3009
Fixing clamp DN100, M8/10	3008-3010
Accessory kit inVENTer PAX ducting	2005-3001
Dust filter inVENTer PAX (1 set)	1004-3001
2K fitting foam (for commercial use only)	1004-0050

10 Troubleshooting and disposal

Troubleshooting

If your ventilation unit is not functioning properly, consult the following troubleshooting table. If the fault persists, contact your supplier, distributor or the technical service department at inVENTer GmbH. For information see section 12: Service.

Fault	Possible cause	Remedy
Ventilation unit without supply air operation.	Dehumidification set too low. PAX in exhaust air mode.	Check the dehumidification level and increase it if necessary.
Noises	Main module is not secured correctly.	Check mounting plate. Align the main module correctly.
LEDs on front plate do not illuminate	Unit not switched on.	Switch on the unit
	Power circuit interrupted.	Check power cable. Check circuit breaker.
Orange Maintenance indicator light flashing	End of maintenance interval has been reached.	Replace dust filters. Press filter change button.
Low airflow	Filters contaminated or defective.	Replace dust filters. Decrease the filter change interval.

Disposal



Dispose of the product in compliance with the applicable national regulations.

The products described in these installation and operating instructions are largely recyclable due to their low-pollutant processing. Contact an electronic appliance disposal company to arrange environmentally friendly recycling and disposal of your old system. Ensure that each product's packaging is sorted correctly for disposal.

Recommendations for disposal can be found in the table below.

Product	Material	Disposal
Main module	Plastic/metal	Drop-off centre for electronic equipment
Infrared remote control	Plastic/metal	Drop-off centre for electronic equipment
Weather protection hood	Stainless steel	Scrap metal collection
Dust filter	Polyester	Household waste

11 Guarantee and warranty

Warranty

Outside Germany, the national warranty provisions of the country in which the system is sold apply. Please contact the distributor for your country.

The warranty refers to the defect-free condition of the product at the time of purchase and covers all defects that were present at the time of purchase. Failure to observe the intended use will invalidate all warranty claims.

Manufacturer guarantee

inVENTer GmbH provides a five-year guarantee for the inVENTer PAX main module. This covers premature product wear.

Further information about the warranty is available at www.inventer.eu/guarantee.

12 Service

Claims

Check the delivery for completeness and transport damage upon receipt using the delivery note. Report missing items immediately, and at the latest within 14 days to your supplier, distributor or factory representative.

Warranty and guarantee claims

In the case of a warranty or guarantee claim, contact your local distributor or factory representative.

In all cases, return the complete device to the manufacturer. The guarantee is an additional offer by the manufacturer and in no way affects the applicable law.

Accessories and spare parts

To order parts for your controller, contact your nearest factory outlet or our service staff.

Technical customer service

For technical support contact our service staff.

Telephone:	+49 (0) 36427 211-0
Telefax:	+49 (0) 36427 211-113
E-Mail:	info@inventer.de
Internet:	www.inventer.eu

COMPANY DETAILS

PUBLISHER:

INVENTER GMBH
ORTSSTRASSE 4A
D-07751 LÖBERSCHÜTZ

TELEPHONE: +49 (0) 36427 211-0
FAX: +49 (0) 36427 211-113
EMAIL: INFO@INVENTER.DE
HOMEPAGE: WWW.INVENTER.EU

CEO: ANNETT WETTIG
VAT ID NUMBER: DE 815494982
JENA DISTRICT COURT HRB 510380

PICTURE CREDITS/ALL RIGHTS RESERVED:
© INVENTER GMBH 2016-17

SUBJECT TO MODIFICATIONS.
ALL INFORMATION IS SUPPLIED WITHOUT GUARANTEE.

NO LIABILITY IS ACCEPTED FOR PRINTING ERRORS.

inVENTer GmbH

Ortsstraße 4a
D-07751 Löberschütz

Telephone: +49 (0) 36427 211-0
Fax: +49 (0) 36427 211-113
Email: info@inventer.de